



MODERN CLASSIC 7500

Residential Aluminum Garage Doors

HÖRMANN

Modern Classic 7500

MC44-DC Dark Bronze Anodized Finish with Satin Etch Glass



Modern Classic 7500

BEST



Door: Ltd Lifetime



Hardware: 5 yr



Springs: 3 yr

- Extruded Aluminum
- 2" Thick Sections

- 12 Finish Colors
- 30 Panel + Window Designs

Thermal Rating



Customizations



Low Maintenance



Luxury Level



Section Detail

SECTION DETAIL Modern Classic panels are constructed using heavy duty commercial grade extruded aluminum stiles and rails. Choose from one of our beautiful anodized or solid powder coat finishes. Obscure and tinted glass as well as solid aluminum and expanded metal panels are also available.

Left Facing Page Image: MC44-DC Dark Bronze

Anodized Finish with Satin Etch Glass

Bottom Left Image: Close-up of a dark bronze

anodized frame with satin etch glass.

Modern Classic 7500

Panel Features

The Industry Leader in Innovative Door Safety, Luxury, and Selection

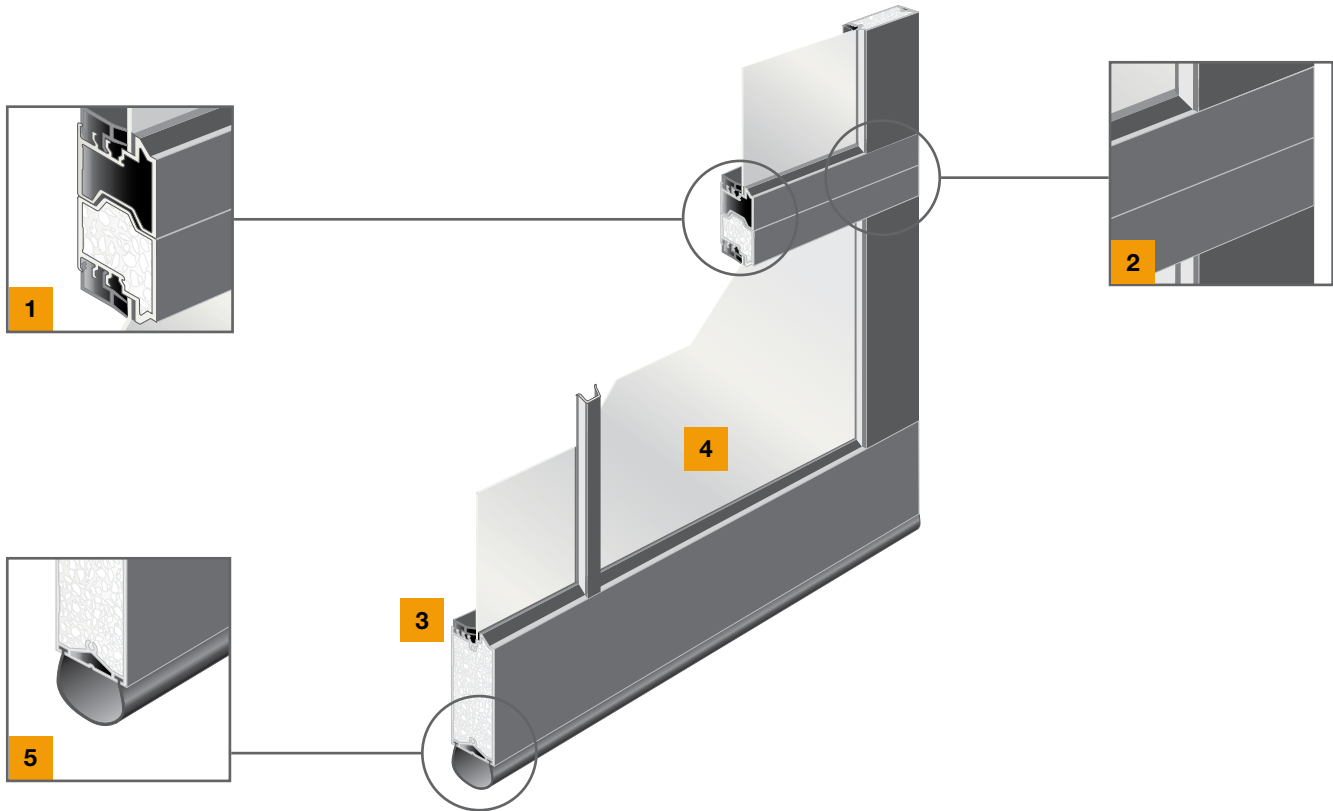

Tongue & Groove Section Joints **1**

Precisely designed thermally broken section joints reduce air infiltration and create weather tight seal.

Glass panels **4**

1/8" clear tempered glass is standard and other obscure or tinted glass are available.

Anodized Aluminum Frame **2**

Frame members are mechanically fastened at joints creating an exceptionally high strength door frame.

Bottom Weather Seal **5**

Keeps out wind, rain, debris and other elements for added energy savings.

Optional Insulation **3**

Options include (EPS) polystyrene insulation in the door frame as well as insulated glass.

Panel Design Options (8' x 7')

CHOOSE YOUR PANEL DESIGN.

Panels come in a wide range of different styles allowing you to choose the perfect match for the design of your home.

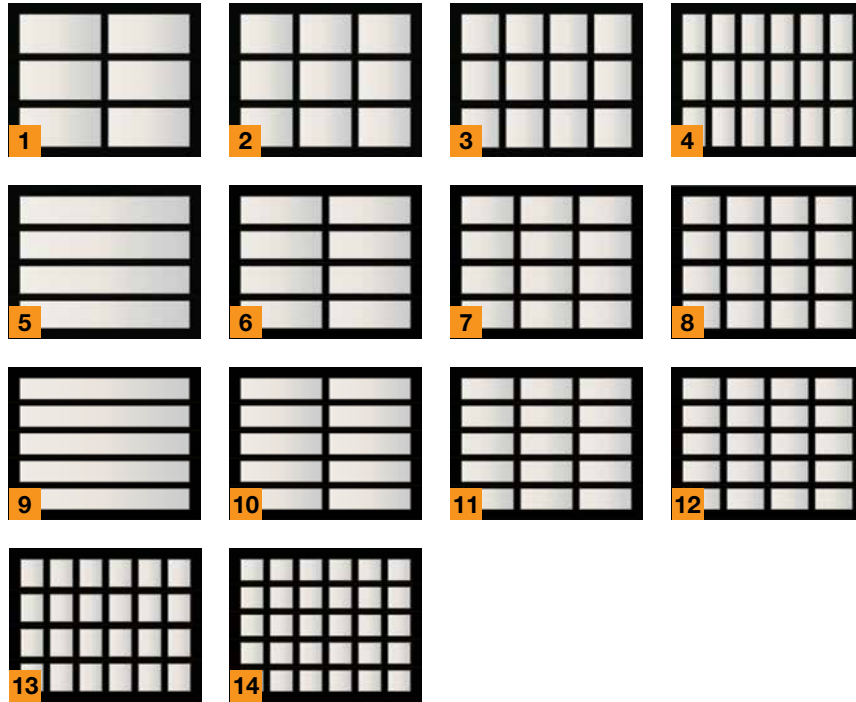

- 1 MC32-SC
- 2 MC33-SC
- 3 MC34-SC
- 4 MC36-SC
- 5 MC41-SC
- 6 MC42-SC
- 7 MC43-SC
- 8 MC44-SC
- 9 MC51-SC
- 10 MC52-SC
- 11 MC53-SC
- 12 MC54-SC
- 13 MC46-SC
- 14 MC56-SC



MC43-SC Clear Anodized Finish with Satin Etch Glass

Modern Classic 7500

Panel Design Options

Panel Design Options (16' x 7')

CHOOSE YOUR PANEL DESIGN.

Panels come in a wide range of different styles allowing you to choose the perfect match for the design of your home.

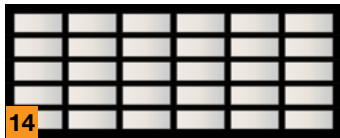
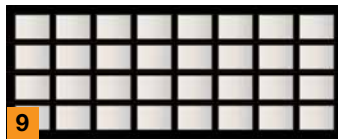
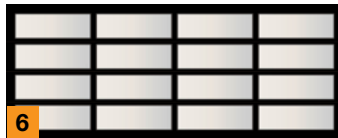
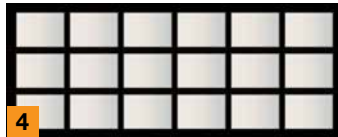
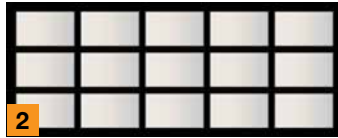

- 1 MC34-DC
- 2 MC35-DC
- 3 MC36-DC
- 4 MC38-DC
- 5 MC42-DC
- 6 MC44-DC
- 7 MC45-DC
- 8 MC46-DC
- 9 MC48-DC
- 10 MC49-DC
- 11 MC52-DC
- 12 MC54-DC
- 13 MC55-DC
- 14 MC56-DC
- 15 MC58-DC
- 16 MC59-DC





Color Options

CHOOSE YOUR BEST MATCH.

Panels are available in twelve standard colors ready for your personal touch to enhance the look of your home.

- 1** Clear Anodized
- 2** Dark Bronze Anodized
- 3** Black Anodized
- 4** White Painted
- 5** Light Ash
- 6** Dark Ash
- 7** Light Cherry
- 8** Dark Cherry*
- 9** Light Fir
- 10** Dark Fir
- 11** Mahogany*
- 12** Dark Walnut*

* Stock wood grain colors have shorter lead times and are offered at a lower price

Glass Options



- 1** Clear
- 2** Greylite
- 3** P516 Obscure
- 4** Bronze
- 5** Mistlite
- 6** Satin Etch
- 7** Frosted Gluechip
- 8** Narrow Reed
- 9** White laminated

HÖRMANN NORTH AMERICA



Sparta, TN - North American Headquarters / Sectional Doors

FIVE PRODUCTION PLANTS, ONE FAMILY



Puyallup, WA - Sectional Doors



Montgomery, IL - Sectional Doors



Barrie, ON (CAN) - High Performance Doors



Burgettstown, PA - High Performance Doors

As one of the world's leading manufacturers of doors we're committed to providing the best quality, value, and selection. Whether residential, commercial or industrial, we have the door you're looking for. Each Hörmann product gives you the perfect array of benefits and options to satisfy your customers.

Eastern and Central US
Toll Free: 877.654.6762
Email: info1@hormann.us
Website: hormann.us

Western US
Toll Free: 800.522.2264
Email: info@northwestdoor.com
Website: northwestdoor.com

Canada
Toll Free:
Email: info@northwestdoorcanada.ca
website: nwdca.ca



AVAILABLE FROM:

